

INN150FQ070A

1. General description

GaN-on-Silicon enhancement mode high-electron-mobility-transistor (HEMT) in FCQFN with 4.0 mm x 6.0 mm package size.

2. Features

- GaN-on-Silicon E-mode HEMT technology
- Industry Application
- Very low gate charge
- Ultra-low on resistance
- Very small footprint

3. Applications

- High frequency DC-DC converter
- Solar Systems optimizers and microinverters
- PD Charger and PSU Synchronous Rectification
- Telecom Power Supply
- Motor driver

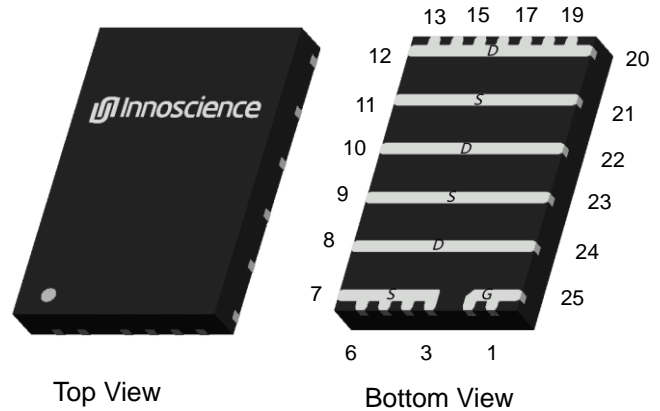
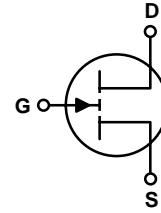

4. Key performance parameters

Table 1 Key performance parameters at $T_J = 25\text{ }^\circ\text{C}$

Parameter	Value	Unit
$V_{DS,max}$	150	V
$R_{DS(on),max}$ @ $V_{GS} = 5\text{ V}$	7	m Ω
$Q_{G,typ}$ @ $V_{DS} = 75\text{ V}$	13	nC
$I_{DS,Pulse}$	160	A
Q_{OSS} @ $V_{DS} = 75\text{ V}$	75	nC

5. Pin information

Table 2 Pin information

Pin	Pin description	Pin function
1,2,25	Gate	Driver Gate
3-7,9,11,21,23	Source	Source
8,10,12-20,22,24	Drain	Power Drain

Table 3 Ordering information

Type/Ordering Code	Package	Product Code
INN150FQ070A	FCQFN 4X6	M03

Table of contents

1. General description	1
2. Features	1
3. Applications.....	1
4. Key performance parameters.....	1
5. Pin information	1
6. Maximum ratings.....	3
7. Thermal characteristics.....	4
8. Electric characteristics	5
9. Electric characteristics diagrams	7
10.Package outlines	12
11.Reel information.....	13
12.Land Pattern	14
13.Revision history	15

6. Maximum ratings

at $T_J = 25\text{ °C}$ unless otherwise specified.

Continuous application of maximum ratings can deteriorate transistor lifetime. For further information, contact Innoscence sales office.

Table 4 Maximum ratings

SYMBOL	PARAMETER	MAX	UNIT
V_{DS}	Drain-to-Source Voltage (Continuous)	150	V
I_D	Continuous current	60	A
	Pulsed (25 °C , $T_{Pulse} = 100\text{ }\mu\text{s}$)	160	A
V_{GS}	Gate-to-Source Voltage	6	V
	Gate-to-Source Voltage	-4	V
T_J	Operating Temperature	-40 to 150	$^{\circ}\text{C}$
T_{STG}	Storage Temperature	-40 to 150	$^{\circ}\text{C}$

7. Thermal characteristics

Table 5 Thermal characteristics

SYMBOL	PARAMETER	TYP	UNIT	Note/Test Condition
$R_{\theta JC}$	Thermal Resistance, Junction to Case	17.04	$^{\circ}C/W$	-
$R_{\theta JB}$	Thermal Resistance, Junction to Board	2.42	$^{\circ}C/W$	-
$R_{\theta JA}$	Thermal Resistance, Junction to Ambient ¹	53.04	$^{\circ}C/W$	-
T_{sold}	Maximum reflow soldering temperature	260	$^{\circ}C$	MSL3

Note 1: $R_{\theta JA}$ is determined with the device mounted on one square inch of copper pad, single layer 2 oz copper on FR4 board.

8. Electric characteristics

at $T_J = 25\text{ }^\circ\text{C}$, unless specified otherwise

Table 6 Static characteristics

SYMBOL	PARAMETER	MIN	TYP	MAX	UNIT	TEST CONDITIONS
BV_{DSS}	Drain-to-Source Voltage	150	-	-	V	$V_{GS} = 0\text{ V}$, $I_D = 1.4\text{ mA}$
I_{DSS}	Drain Source Leakage	-	1.5	150	μA	$V_{GS} = 0\text{ V}$, $V_{DS} = 150\text{ V}$
I_{GSS}	Gate-to-Source Forward Leakage	-	1.5	100	μA	$V_{GS} = 5\text{ V}$
	Gate-to-Source Forward Leakage	-	4.0	1000	μA	$V_{GS} = 6\text{ V}$
	Gate-to-Source Reverse Leakage	-	0.1	100	μA	$V_{GS} = -4\text{ V}$
$V_{GS(TH)}$	Gate Threshold Voltage	0.8	1.1	2.1	V	$V_{DS} = V_{GS}$, $I_D = 7\text{ mA}$
$R_{DS(on)}$	Drain-Source On-state Resistance	-	5.4	7	$\text{m}\Omega$	$V_{GS} = 5\text{ V}$, $I_D = 20\text{ A}$
V_{SD}	Source-Drain Forward Voltage	-	1.5	-	V	$I_S = 0.5\text{ A}$, $V_{GS} = 0\text{ V}$

Table 7 Dynamic characteristics

SYMBOL	PARAMETER	MIN	TYP	MAX	UNIT	TEST CONDITIONS
C _{ISS}	Input Capacitance	-	1450	-	pF	V _{GS} = 0 V, V _{DS} = 75 V
C _{OSS}	Output Capacitance	-	525	-		V _{GS} = 0 V, V _{DS} = 75 V
C _{RSS}	Reverse Transfer Capacitance	-	7	-		V _{GS} = 0 V, V _{DS} = 75 V
C _{OSS(ER)}	Energy Related C _{OSS}	-	740	-		V _{GS} = 0 V, V _{DS} = 0 V to 75 V
C _{OSS(TR)}	Time Related C _{OSS}	-	1000	-		V _{GS} = 0 V, V _{DS} = 0 V to 75 V
R _G	Gate resistance	-	2	-	Ω	f = 5MHz, open drain
Q _G	Total Gate Charge	-	13	-	nC	V _{GS} = 5 V, V _{DS} = 75 V, I _D =20 A
Q _{GS}	Gate to Source Charge	-	3	-		V _{DS} = 75 V, I _D =20 A
Q _{GD}	Gate to Drain Charge	-	2	-		V _{DS} = 75 V, I _D =20 A
Q _{G(TH)}	Gate Charge at Threshold	-	1.5	-		V _{DS} = 75 V, I _D =20 A
Q _{OSS}	Output Charge	-	75	-		V _{GS} = 0 V, V _{DS} = 75 V

9. Electric characteristics diagrams

at $T_J = 25^\circ\text{C}$, unless specified otherwise

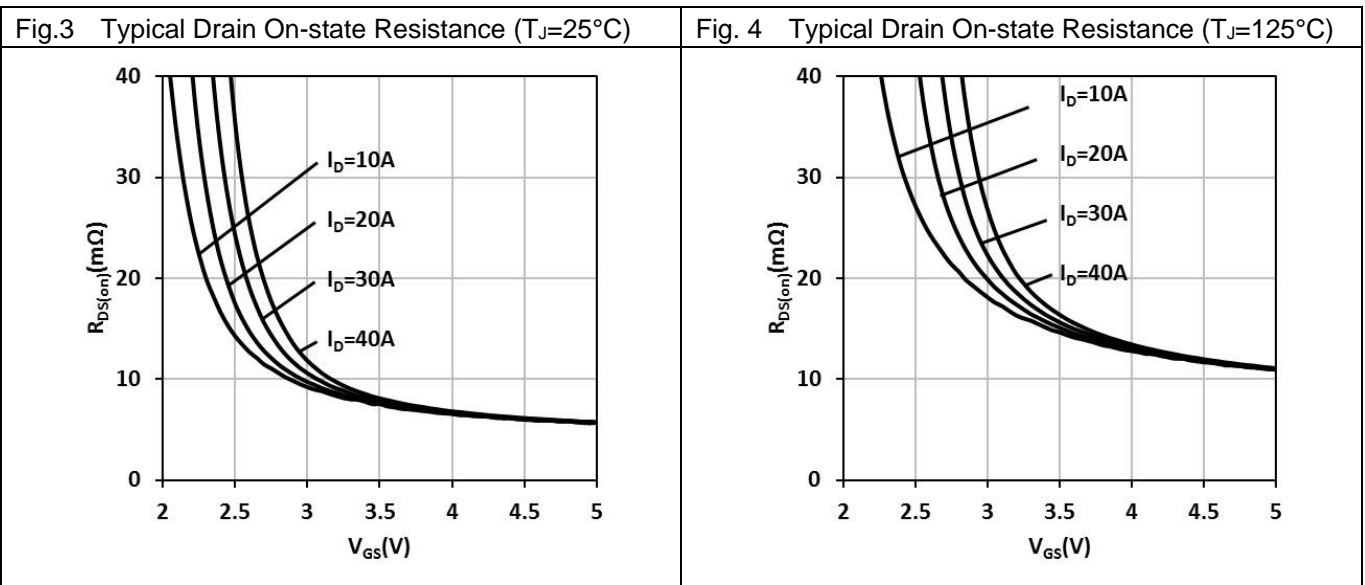
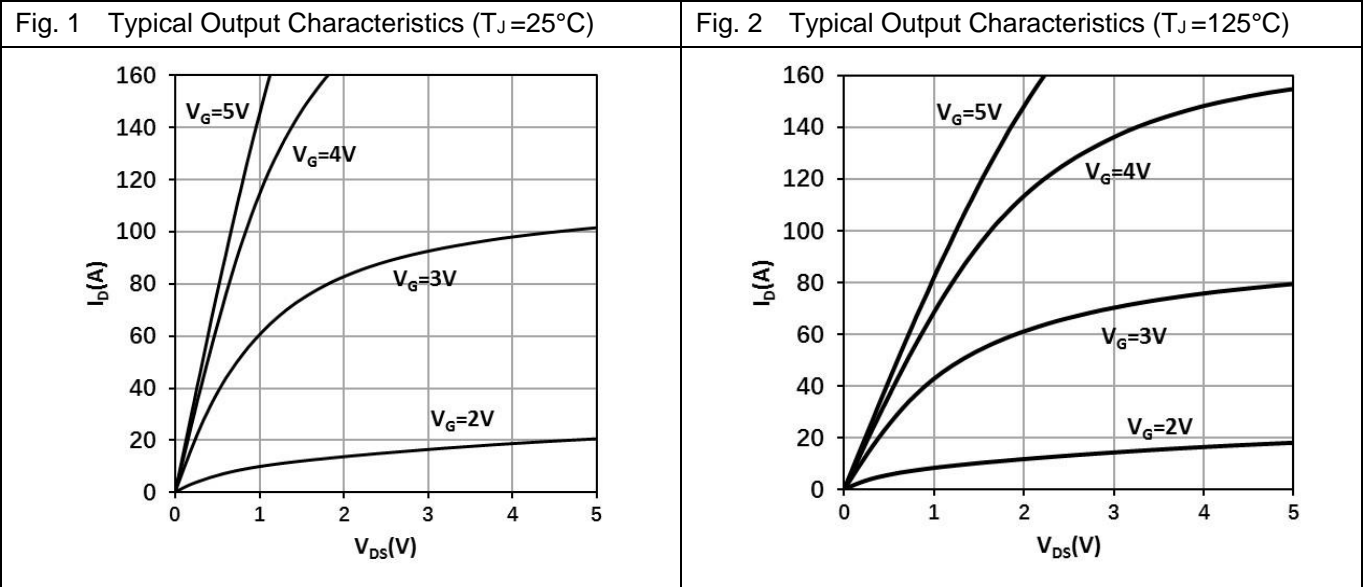

Fig. 5 Normalized On-State Resistance vs. Temp.

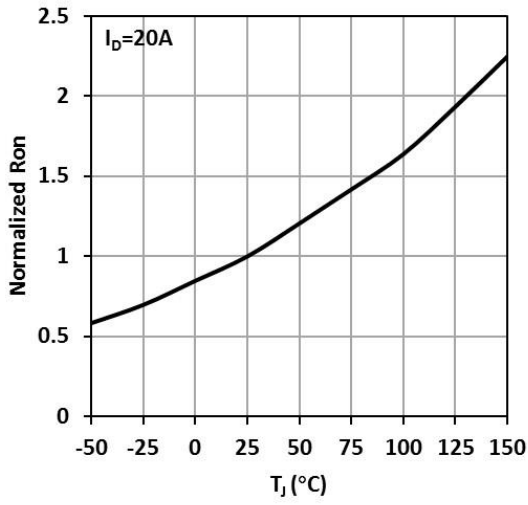

Fig. 6 Typical Transfer Characteristics

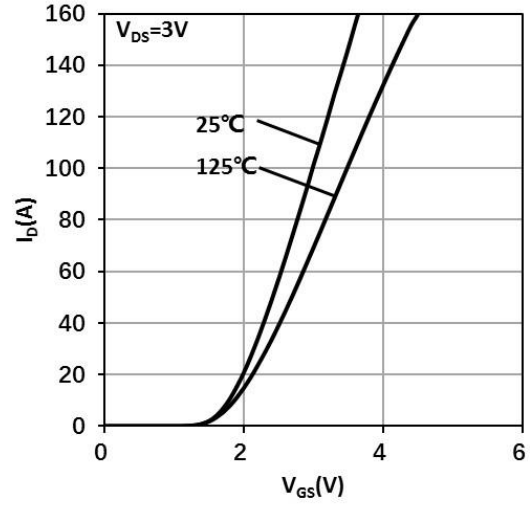

Fig. 7 Typ. Reverse Drain-Source Characteristics ($V_{GS} \leq 0$, $T_J = 25^\circ\text{C}$)

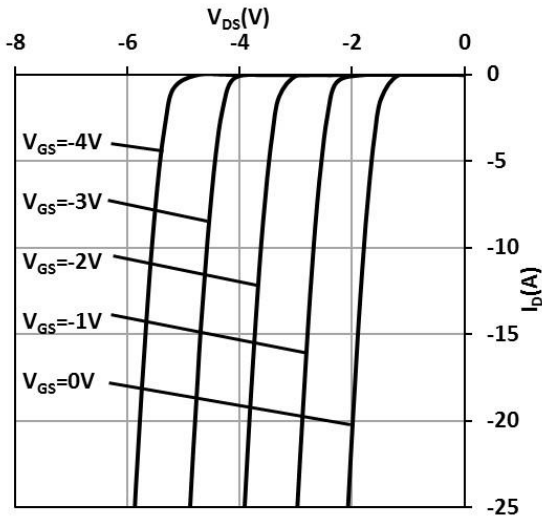

Fig. 8 Typ. Reverse Drain-Source Characteristics ($V_{GS} \geq 0$, $T_J = 25^\circ\text{C}$)

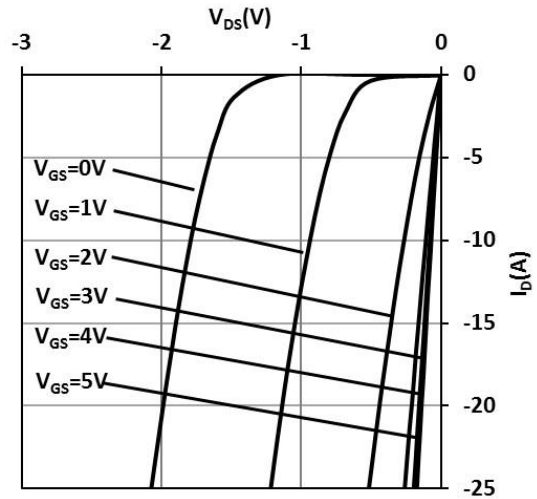

Fig. 9 Typ. Reverse Drain-Source Characteristics ($V_{GS} \leq 0$, $T_J = 125^\circ\text{C}$)

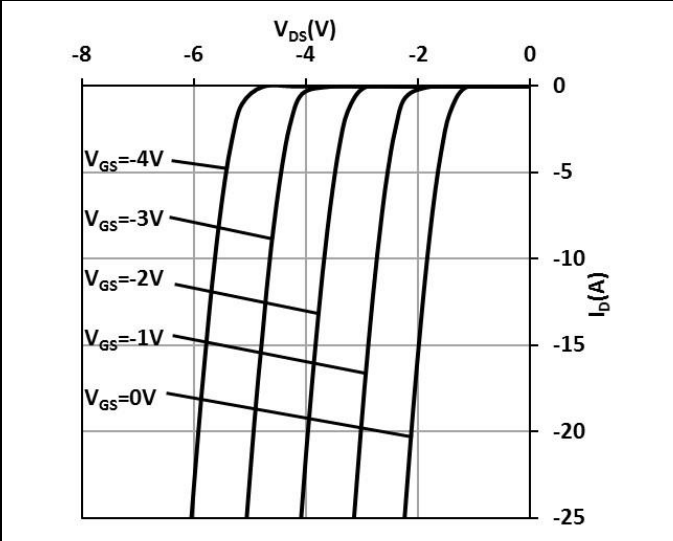

Fig. 10 Typ. Reverse Drain-Source Characteristics ($V_{GS} \geq 0$, $T_J = 125^\circ\text{C}$)

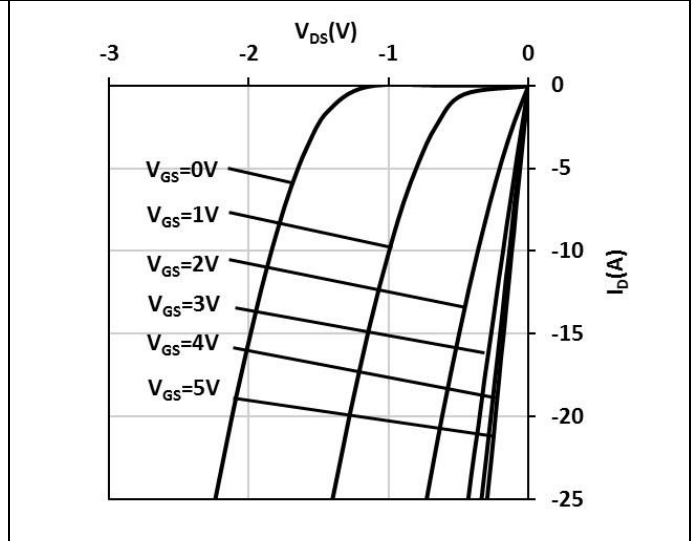

Fig. 11 Typ. Capacitances Characteristics

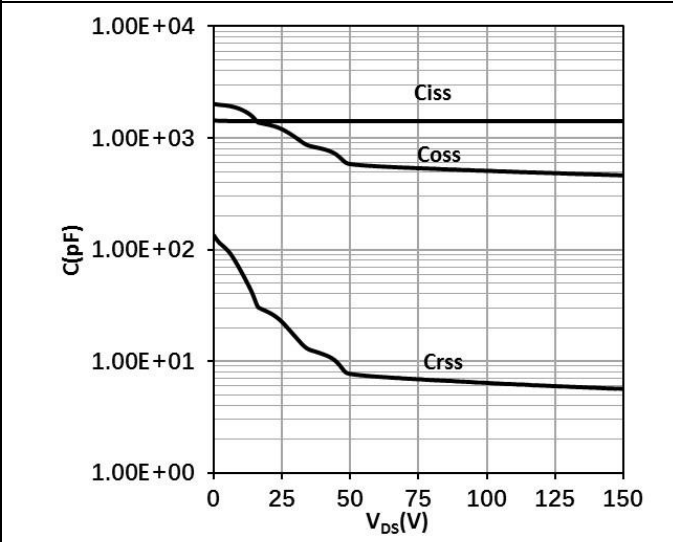

Fig. 12 Typ. Gate Charge

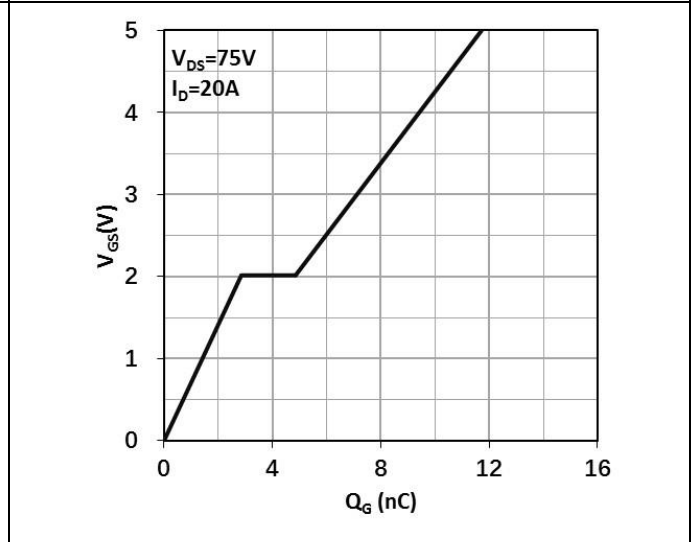

Fig. 13 Normalized Threshold Voltage vs. Temp.

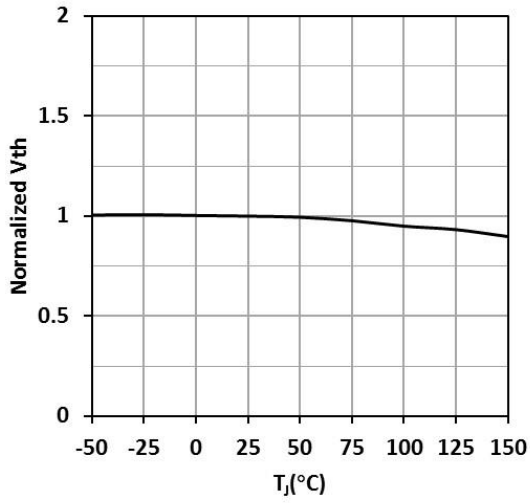

Fig. 14 Output Charge

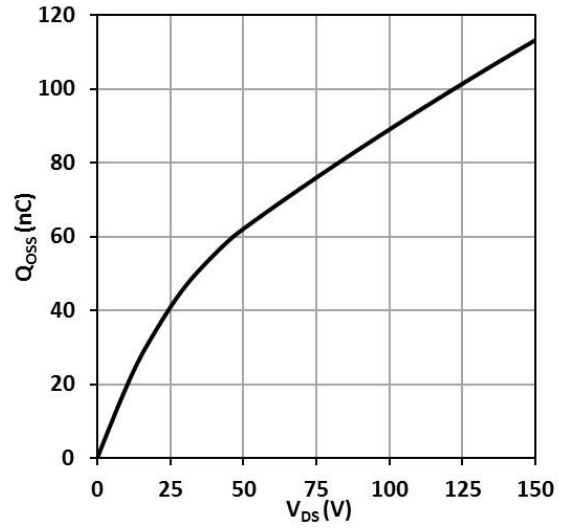

Fig. 15 Output Capacitance Stored Energy

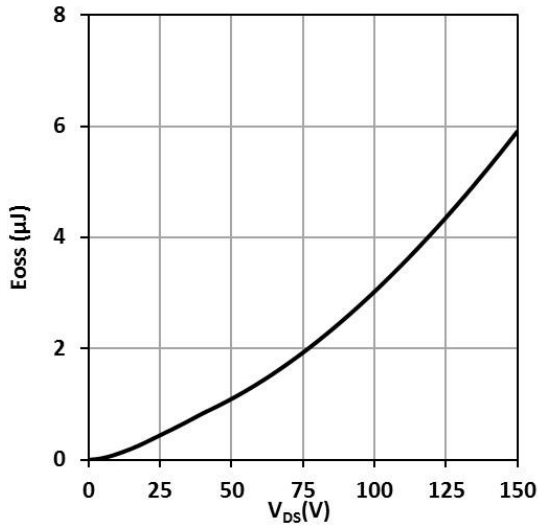

Fig. 16 Power Dissipation

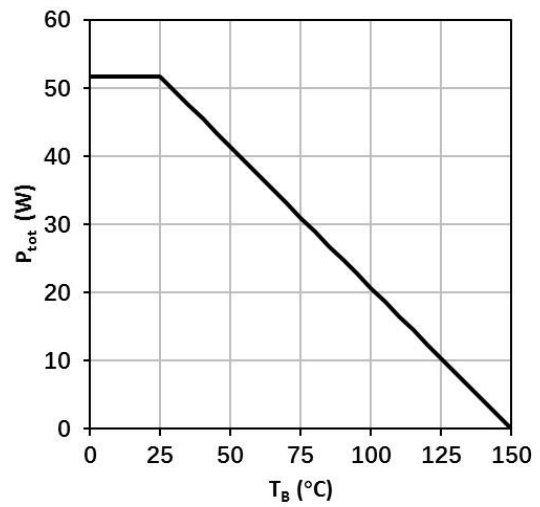

Fig. 17 Safe Operating Area

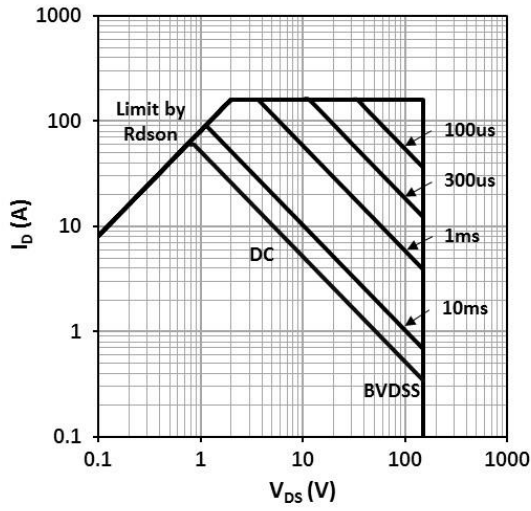
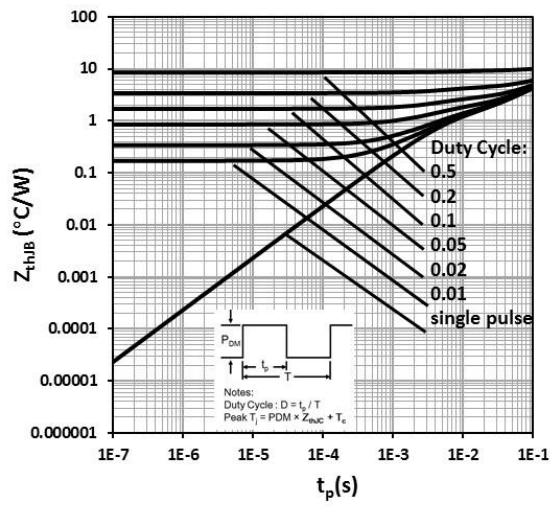
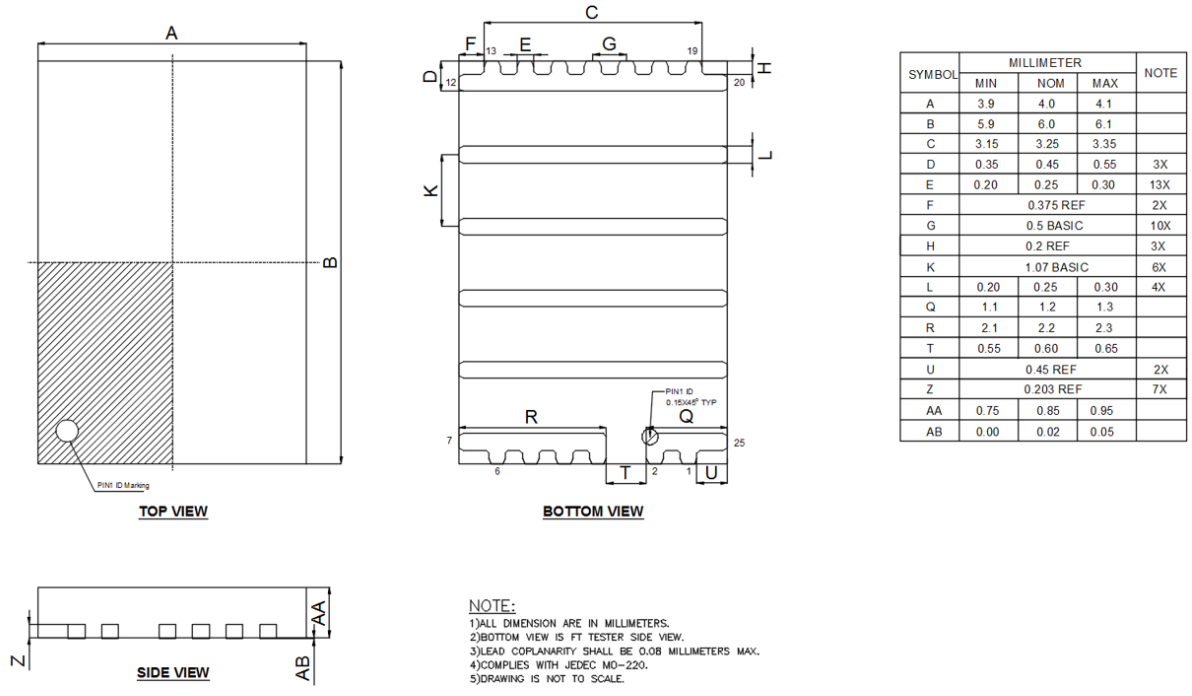

Fig. 18 Max. Transient Thermal Impedance



10. Package outlines

Package Reference



PIN configuration

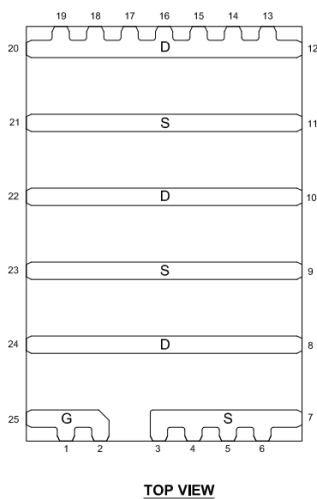

Marking Reference

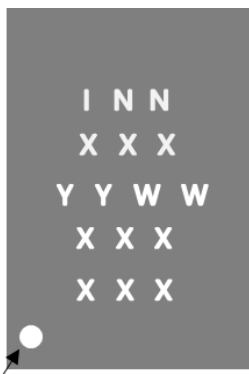

Die Orientation Dot
& Gate Position

Row ¹	Description ²	Example ³
Row 1 ⁴	Company name ⁴	INN ⁴
Row 2 ⁴	Product code ⁴	XXX ⁴
Row 3 ⁴	Date code ⁴	YYWW ⁴
Row 4 ⁴	Lot No ⁴	XXX ⁴
Row 5 ⁴	Lot No ⁴	XXX ⁴

11. Reel information

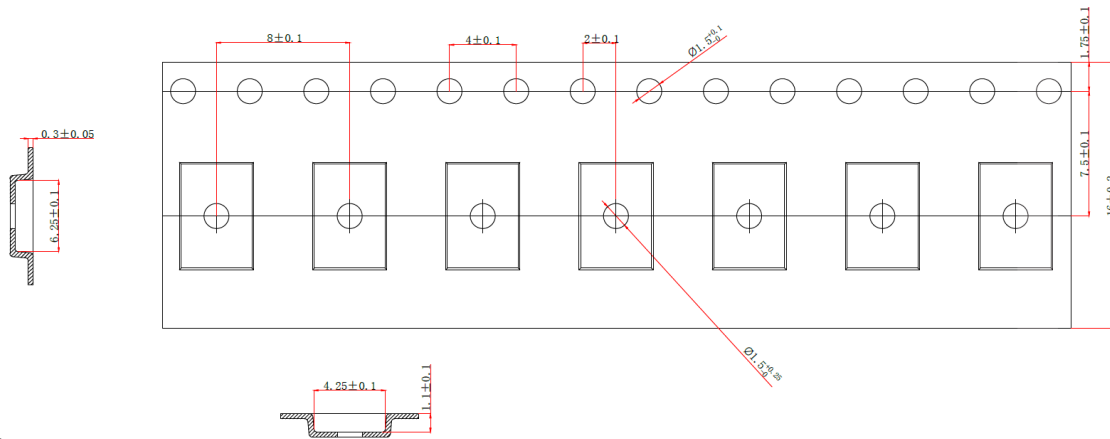

NOTES:

1. CARRIER TAPE COLOR: BLACK.
2. COVER TAPE WIDTH: 13.3±0.10.
3. COVER TAPE COLOR: TRANSPARENT.
4. 10 SPROCKET HOLE PITCH CUMULATIVE TOLERANCE ±0.20 MAX.
5. CAMBER NOT TO EXCEED 1MM IN 100MM.
6. MOLD# QFN/DFN/MIS6X4X0.75/0.85.
7. ALL DIMS IN MM.
8. BAN TO USE THE ENVIRONMENT-RELATED SUBSANCES OF JCET PRESCRIBING.

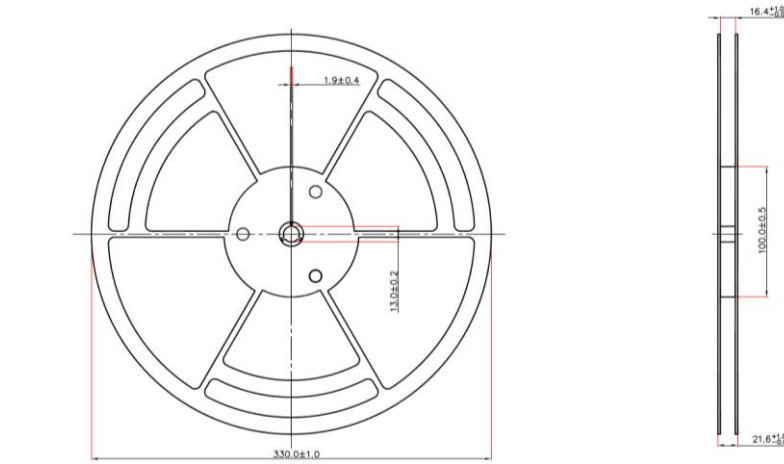

NOTES:

1. 2500 UNITS PER TRAY.
2. COLOR: WHITE.
3. ALL DIM IN mm.
4. GENERAL TOLERANCE±0.25.
5. BAN TO USE THE ENVIRONMENT-RELATED SUBSANCES OF JCET PRESCRIBING.
6. THE DERECTION OF VIEW:

13. Revision history

Major changes since the last revision

Revision	Date	Description of changes
1.0	2023-11-29	Version 1.0 release

Important Notice

The information provided in this document is intended as a guide only and shall not in any event be regarded as a guarantee of conditions, characteristics or performance. Innoscience does not assume any liability arising out of the application or use of any product described herein, including but not limited to any personal injury, death, or property or environmental damage. No licenses, patent rights, or any other intellectual property rights is granted or conveyed. Innoscience reserves the right to modify without notice. All rights reserved.